

In preparation for: Int J Biochem Cell Biol

2017-08-10; Version 10

Full-length review

Mitochondrial respiratory control:

a conceptual perspective on coupling states in mitochondrial preparations.

MITOEAGLE recommendations Part 1

MITOEAGLE Terminology Group

Corresponding author: E. Gnaiger

Contributing authors (alphabetical, *to be extended*):

M.G. Alves, R. Brown, A.J. Chicco, P.M. Coen, J. Collins, L. Crisostomo, T. Dias, G. Distefano, C. Doerrier, H. Dubouchaud, P.M. Garcia-Roves, L.F. Garcia-Souza, E. Gnaiger, K.T. Hellgren, C.L. Hoppel, J. Iglesias-Gonzalez, P. Jansen-Dürr, B.H. Goodpaster, B.A. Irving, S. Iyer, G. Keppner, T. Komlodi, A. Krajcova, G. Krumschnabel, H.K. Lee, M. Markova, T. Masashi, A.T. Meszaros, A. Molina, A.L. Moore, C.M. Palmeira, R.K. Porter, K. Nozickova, K. Renner-Sattler, K. Siewiera, O. Sobotka, P. Stankova, Z. Sumbalova, L.

Tretter, B. Velika

Supporting co-authors:

[Mitochondrial respiratory control: MITOEAGLE recommendations 1](#)

Correspondence: E. Gnaiger

Department of Visceral, Transplant and Thoracic Surgery, D. Swarovski Research Laboratory, Medical University of Innsbruck, Innrain 66/4, A-6020 Innsbruck, Austria

Email: erich.gnaiger@oroboros.at, Tel: +43 512 566796, Fax: +43 512 566796 20

Abstract

Clarity of concepts and consistency of nomenclature is a hallmark of the quality of a research area across its specializations, aimed at facilitating transdisciplinary communication and teaching. The expanding field of mitochondrial respiratory physiology can benefit from harmonization of nomenclature on mitochondrial respiratory states and rates. Peter Mitchell's protonmotive, chemiosmotic force across the inner mitochondrial membrane, Δp_{mt} , establishes the link between electron transfer and phosphorylation of ADP to ATP, and between the electric and chemical components of energy transformation ($\Delta p\text{H}$ and $\Delta \Psi_{\text{m}}$). This unifying concept provides the framework for developing a consistent terminology on mitochondrial physiology and bioenergetics. We follow IUPAC guidelines on general terms of physical chemistry, extended by concepts of nonequilibrium thermodynamics and open systems. The differential nomenclature of respiratory states in classical bioenergetics (States 1 to 5 in an experimental protocol) is incorporated into a concept-driven constructive terminology to address the basic meaning of each respiratory state and focus primarily on the conceptual 'why' with clarification of the experimental 'how'. LEAK states are evaluated to study arrested respiration, L , when oxygen consumption compensates mainly for the proton leak. OXPHOS capacity, P , is measured at saturating concentrations of ADP and inorganic phosphate to obtain kinetic reference values for diagnostic applications. The ETS state differentiates the oxidative capacity of the electron transfer system, E , from P , revealing the limitation of OXPHOS capacity by the capacity of the phosphorylation system. The application of strictly defined terms for comparison of respiratory states is necessary before addressing future goals such as the development of databases on mitochondrial respiratory control requires the application of strictly defined terms for comparison of respiratory states.

Keywords: Mitochondrial respiratory control, coupling control; mitochondrial preparations, protonmotive force, oxidative phosphorylation, OXPHOS; electron transfer

Kommentiert [PG1]: I am not sure about word count limits. But I think a sentence similar to this is more precise and lead to our future actions. At the same time explains why this manuscript is needed.

system, ETS; proton leak, LEAK; residual oxygen consumption, ROX; State 2, State 3, State 4.

1. Introduction

Every study of mitochondrial function and disease in tissues and cells is faced with evolution, age, gender, lifestyle and environment (EAGLE) as essential background conditions characterizing the individual patient or subject, cohort, species, tissue and even cell line. Only a large and coordinated network can manage to generate the necessary type, quality and number of consistent data sets to address this intrinsic complexity. The global MITOEAGLE network aims at developing harmonized experimental protocols and implementing a quality control and data management system to interrelate results obtained in different studies and generate a rigorously monitored database on mitochondrial respiratory function.

Reliability and comparability of quantitative results depends on accuracy of measurement under well-defined conditions. A conceptually meaningful framework is required to relate the results carried out by different research groups. Vague or ambiguous terminology can lead to confusion and may turn valuable signals into wasteful noise. For this reason, measurements must be expressed in common units on each well-defined attribute for mitochondrial respiratory control. Even if standardization of nomenclature remains a goal of the optimist and is out of reach in the real world, harmonization of the technical jargon will improve the awareness of the intricate meaning of divergent scientific vocabulary. The MITOEAGLE Terminology Group aims at accomplishing the ambitious goal to harmonize, unify and thus simplify the terminology in the field of mitochondrial physiology. A focus on coupling states in mitochondrial preparations may be considered as a first step in the attempt to elaborate a harmonized and conceptually oriented nomenclature in bioenergetics and mitochondrial physiology.

Mitochondria, mt (Greek mitos: thread; chondros: granule) are small structures with a double membrane within cells, which function as powerhouses or batteries in cell respiration. Mitochondria belong to the bioblasts of Richard Altmann (1894), which comprise mitochondria and symbiotic as well as free-living bacteria. Mitochondria are the oxygen consuming organelles, where the reduction of O₂ is coupled to conservation of energy in the form of ATP (oxidative phosphorylation; OXPHOS). Abbreviation: mt, as generally used in mtDNA. Singular: mitochondrion; plural: mitochondria.

Mitochondrial preparations, mtprep, are defined as tissue or cell preparations in which the plasma membranes are either removed (isolated mitochondria, imt), or mechanically and/or chemically permeabilized (tissue homogenate, thom; permeabilized fibres, pfi; permeabilized cells, pce), while mitochondrial functional integrity and to a large extent the mt-structure are maintained.

2. Fundamental respiratory coupling states in mitochondrial preparations

‘Every professional group develops its own technical jargon for talking about matters of critical concern ... People who know a word can share that idea with other members of their group, and a shared vocabulary is part of the glue that holds people together and allows them to create a shared culture’ (Miller 1991).

Mitochondrial respiratory control is exerted in mt-preparations by experimental conditions defined as respiratory states. In coupling states the phosphorylation of ADP to ATP is stimulated or depressed which causes an increase or decrease of electron flow linked to oxygen consumption. Alternatively, coupling of electron flow and phosphorylation is disengaged by uncouplers, which induces a burst of oxygen consumption without performance of biochemical work (Fig. 1). Coupling states in mt-preparations depend on exogenous supply of fuel substrates and oxygen to support the electron transfer system (Fig. 2).

Kommentiert [PG2]: After reading this section until Fig 1. and Fig2. my opinion is that it could be difficult to understand for new scientist in the field. Once you go step by step you can follow and understand the series of events but it will be hard to pick up for new comers starting from the biophysics. Could we start with a simplified explanation of Peter Mitchell's protonmotive, chemiosmotic force (for beginners) and then follow as it is. One option could be to start with Figure 2A and then follow by Fig1 and FIG2B.

Kommentiert [PG3]: "Energy production"? "performance of biochemical work" seems a general term without a precise meaning.

Coupling and efficiency: In an energy transformation, τ , coupling occurs between processes, if a coupling mechanism allows work to be performed on the endergonic or uphill output process (work per unit of time is power; dW_{out}/dt [J/s] = P_{out} [W]; with a positive partial Gibbs energy change) driven by the exergonic or downhill input process (with a negative partial Gibbs energy change). At the limit of maximum efficiency of a completely coupled system, the (negative) input power equals the (positive) output power, such that the total power equals zero at an efficiency of 1. If the coupling mechanism is taken away, the output process becomes independent of the input, and both proceed in their downhill direction (Fig. 1).

Phosphorylation, »P: Although ‘phosphorylation’ in the context of OXPHOS is clearly defined as phosphorylation of ADP to ATP, substrate level phosphorylation may be involved as part of the tricarboxylic acid cycle (succinyl-CoA ligase) and in the matrix (phosphoenolpyruvate carboxykinase), and in the cytosol (pyruvate kinase, phosphoglycerate kinase). In isolated mitochondria, high adenylate kinase related ATP production can be observed in the presence of ADP and without respiratory substrates (Komlodi et al 2017). On the other hand, the term phosphorylation is used in the general literature in many different contexts (phosphorylation of enzymes, etc.). This justifies consideration of a symbol more discriminative than P as used in the P/O ratio (phosphate to O ratio), where P indicates phosphorylation of ADP to ATP or GDP to GTP. We might consider the symbol »P for the energetic uphill direction of phosphorylation coupled to catabolic reactions, and likewise the symbol «P for the corresponding downhill reaction (Fig. 1).

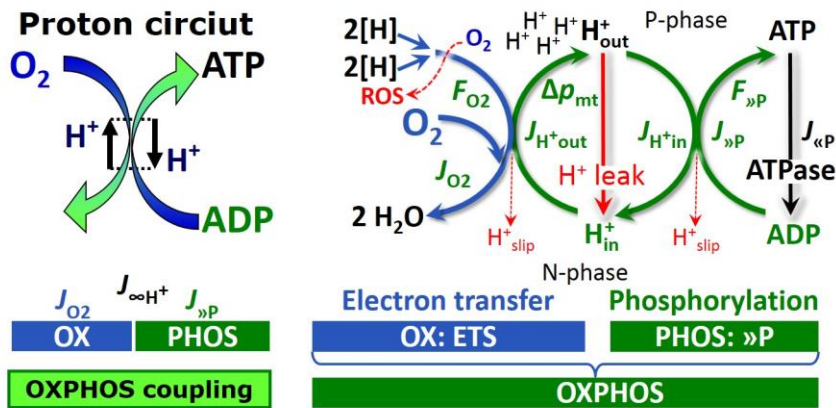

Fig. 1. The proton circuit and coupling in oxidative phosphorylation (OXPHOS). Oxygen flux, J_{O_2} , is coupled to the phosphorylation of ADP to ATP, $J_{\gg P}$, by the proton pumps of the electron transfer system (ETS) pushing the outwards proton flux, J_{H^+out} . The ATP synthase is driven by the protonmotive force, Δp_{mt} , and inwards proton flux, J_{H^+in} , to phosphorylate ADP to ATP. $2[H]$ indicates the reduced hydrogen equivalents of fuel substrates providing the chemical input force or molar Gibbs energy, F_{O_2} [kJ/mol O_2], of the reaction with oxygen, typically in the range of -460 to -480 kJ/mol. The output force is given by the phosphorylation potential, $F_{\gg P}$ [kJ/mol ADP phosphorylated to ATP], which varies *in vivo* in the range of about 48 to 62 kJ/mol under physiological conditions. Proton turnover, $J_{\infty H^+}$, and ATP turnover, $J_{\gg P}$, proceed in the steady state at constant Δp_{mt} , when $J_{\infty H^+} = J_{H^+out} = J_{H^+in}$, and at constant phosphorylation potential, $F_{\gg P}$, when $J_{\gg P} = J_{\ll P} = J_{\ll P}$. $J_{\gg P}/J_{O_2}$ is two times the 'P/O' ($\gg P/O$) ratio of classical bioenergetics. The effective $J_{\gg P}/J_{O_2}$ ratio is diminished by (i) the proton leak across the inner mt-membrane from low pH in the positive P-phase to the negative N-phase, (ii) cycling of other cations, (iii) proton slip of the proton pumps, and (iv) electron leak generating reactive oxygen species, ROS. Modified after Gnaiger (2014).

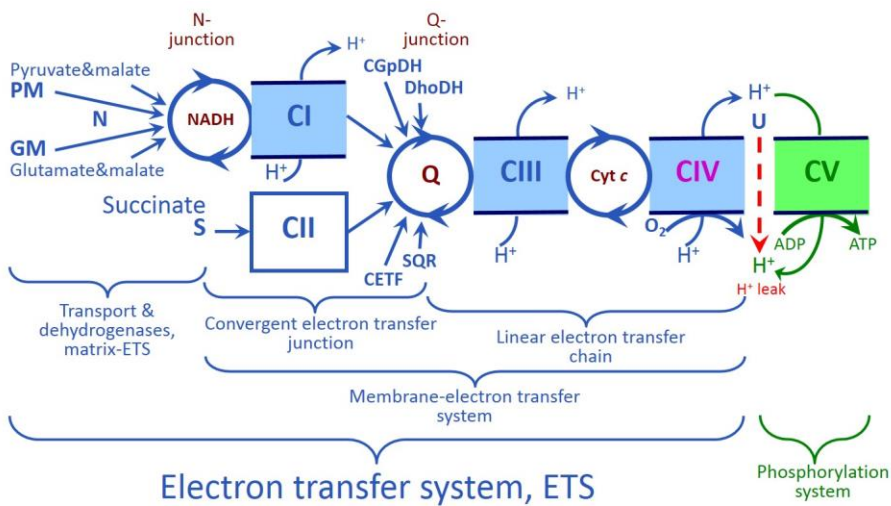
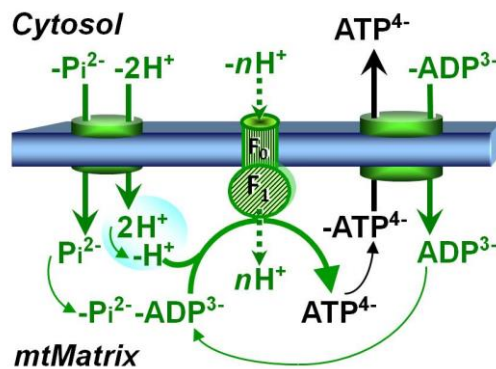

Fig. 2. The mitochondrial respiratory system. In oxidative phosphorylation the electron transfer system (A) is coupled to the phosphorylation system (B). Modified after (A) Lemieux et al (2017) and (B) Gnaiger (2014).



2.1. Classical terminology for isolated mitochondria (*imt*)

'It is essential to define both the substrate and ADP levels in order to identify the steady-state condition of the mitochondria during the experiment' (Chance and Williams, 1956).

Five classical states of mitochondrial respiration and cytochrome redox states have been introduced by Chance and Williams (1955; 1956). Table 1 explains a protocol with isolated mitochondria (*imt*) in a closed respirometric chamber, defining a consecutive sequence of respiratory states.

State 1 is obtained after addition of imt to air-saturated isoosmotic/isotonic respiration medium containing inorganic phosphate, but no adenylates (i.e. AMP, ADP, ATP) and no fuel substrates.

State 2 is induced by addition of a high concentration of ADP, which stimulates respiration transiently on the basis of endogenous fuel substrates, followed by a low respiratory activity limited by endogenous fuel substrate availability.

State 3 is the state stimulated by addition of fuel substrates while the ADP content is still high and supports coupled energy transformation in oxidative phosphorylation.

State 4 is only reached if the imt preparation is of high quality and is well coupled. Depletion of ADP by phosphorylation to ATP will then lead to a decline in oxygen uptake in the transition from State 3 to State 4. Under these conditions a maximum Δp_{mt} and high ATP/ADP ratio are maintained. State 4 respiration reflects intrinsic proton leak and ATPase activity.

State 5 is a state obtained after exhaustion of oxygen in a closed respirometric chamber. Oxygen backdiffusion into the aqueous solution may be a cofounding factor preventing complete anoxia (Gnaiger 2001).

Table 1. Metabolic states of mitochondria (after Chance and Williams, 1956).

State	[O ₂]	[ADP]	[Substrate]	Respiration rate	Rate-limiting substance
1	>0	Low	Low	Slow	ADP
2	>0	High	~0	Slow	Substrate
3	>0	High	High	Fast	respiratory chain
4	>0	Low	High	Slow	ADP
5	<0	High	High	0	Oxygen

2.2. Three fundamental coupling states of mitochondrial preparations and residual oxygen consumption.

It has been suggested to extend the differential nomenclature (States 1 to 5) by a concept-driven terminology carrying explicit information on the nature of the respiratory states. This terminology must be general and not restricted to any particular experimental protocol or mt-preparation. This provides a platform to expand the classical respiratory states with the extended constructive framework in the theory of mitochondrial physiology.

LEAK state (Fig. 3):

A state of mitochondrial respiration when oxygen flux is maintained mainly to compensate for the proton leak in the absence of ATP synthesis, in the presence

of fuel substrates and oxygen. The **LEAK** state can be established either in

the absence of adenylates, after depletion of ADP at maximum ATP/ADP ratio, and after inhibition the phosphorylation system by inhibitors such as oligomycin (ATP synthase) or carboxyatractyloside (adenylate nucleotide translocase). State 4 represents an overestimation of LEAK respiration if ATPase activity prevents final accumulation of ATP and maintains a continuous stimulation of respiration by recycled ADP at $J_{\gg P} > 0$. This can be tested by inhibition of the phosphorylation system using oligomycin, ensuring that $J_{\gg P} = 0$.

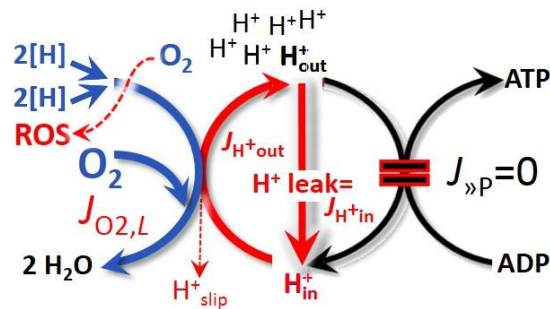

Fig. 3. LEAK state when phosphorylation is arrested, $J_{\gg P} = 0$, and **LEAK** oxygen flux, $J_{O_2,L}$, is controlled mainly by the proton leak, which equals $J_{H^+,in}$, at maximum Δp_{mt} (compare Fig. 1).

Formatiert: Hervorheben

Kommentiert [PG4]: In Fig.3. We do not need the term LEAK before oxygen flux.

OXPHOS state (Fig. 4): In mitochondrial physiology and pathology, maximal mitochondrial respiration in the *coupled* state is measured for quantitative determination of oxidative phosphorylation (OXPHOS) capacity (Gnaiger 2009). The OXPHOS state is supported by kinetically

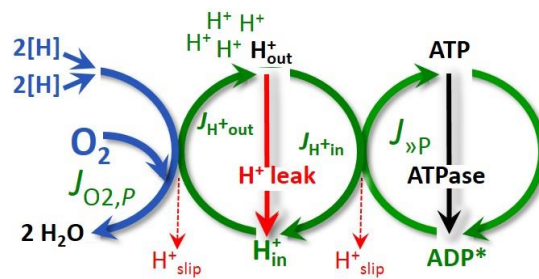

Fig. 4. OXPHOS state when phosphorylation, $J_{\gg P}$, is supported by a high Δp_{mt} , is stimulated by saturating $[ADP]^*$ and $[Pi]^*$, and oxygen flux, $J_{O2,P}$, is highly coupled at a maximum $\gg P/O_2$ ratio, $J_{\gg P}/J_{O2,P}$ (compare Fig. 1).

saturating ADP, $[ADP]^*$, and inorganic phosphate concentrations, $[Pi]^*$, in the presence of fuel substrates and oxygen. In contrast, the definition of State 3 lacks a fundamental attribute of OXPHOS capacity. As previously highlighted, 'high ADP' in State 3 is a concentration of ADP specifically selected to allow the measurement of a State 3 to State 4 transitions of isolated mitochondria in a closed respirometric system. Starting at oxygen concentrations near air saturation, the ADP concentration added must be low enough to allow phosphorylation to ATP at a coupled oxygen consumption that does not lead to oxygen depletion during the transition to State 4. In contrast, OXPHOS capacity requires evaluation of kinetically saturating ADP concentrations, which are usually an order of magnitude higher than 'high ADP'. When subtracting LEAK respiration from OXPHOS capacity, the dissipative LEAK component may be overestimated. This can be avoided by measurement of LEAK respiration in a state when the protonmotive force, Δp_{mt} , is adjusted to the slightly lower value maintained in the OXPHOS state. Any turnover-dependent components of proton leak and slip, however, are underestimated under these conditions (Garlid et al 1993).

Kommentiert [PG5]: We talk about the need of $[Pi]^*$ to assess OXPHOS but we do not represent in our Figures with exception of Fig.2A. Should we included in Fig.1, 4 ...?

As discussed previously, 0.2 mM ADP does not fully saturate flux in isolated mitochondria (Puchowicz et al., 2004; Gnaiger, 2001), and even higher ADP concentrations are required particularly in permeabilized fibres to overcome limitations by diffusion and by the tubulin-regulated conductance of the outer mitochondrial membrane (Rostovtseva et al., 2008). In permeabilized muscle fibre bundles of high respiratory capacity, the apparent K_m for ADP increases up to 0.5 mM (Saks et al., 1998). This implies that >90 % saturation is reached only at >5 mM ADP.

ETS state (Fig. 5): The electron transfer system state is the noncoupled state at optimal exogenous uncoupler concentration for maximum oxygen flux as a measure of ETS capacity, in the presence of fuel substrates and oxygen. As a consequence of the

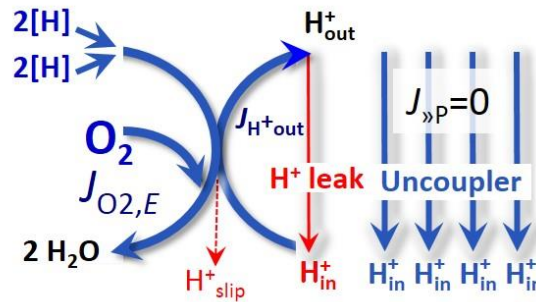

Fig. 5. ETS state when noncoupled respiration, $J_{O_2,E}$, is maximum at optimum exogenous uncoupler concentration and phosphorylation is zero, $J_{>>P}=0$ (compare Fig. 1).

nearly collapsed Δp_{mt} , the driving force for phosphorylation is missing and $J_{>>P}=0$. The abbreviation State 3u is used frequently in bioenergetics, to indicate the state of maximum respiration without sufficient emphasis on the fundamental difference between OXPHOS capacity (coupled, with an endogenous uncoupled component) and ETS capacity (noncoupled).

ROX: Residual oxygen consumption (ROX) is defined as respiration due to oxidative side reactions remaining after inhibition of the ETS. ROX is not a coupling state but

represents a baseline that is used to correct mitochondrial respiration in defined coupling states. ROX is not necessarily equivalent to non-mitochondrial respiration, considering oxygen-consuming reactions in mitochondria not related to ETS, such as oxygen consumption in the monoaminoxidase catalyzed reaction. In the presence of oxygen, ROX is measured either in the absence of fuel substrates or after blocking the electron supply to cytochrome *c* oxidase and alternative oxidases.

3. States and rates

3.1. The steady-state

Steady-state variables (membrane potential; redox states) and metabolic fluxes (rates) are measured in defined mitochondrial respiratory states. Strictly steady states can be obtained only in open systems, in which changes due to internal transformations (e.g. oxygen consumption) are instantaneously compensated by external flows (e.g. oxygen supply), such that oxygen concentration does not change in the system (Gnaiger 1993b). Mitochondrial respiratory states monitored in closed systems may satisfy the criteria of pseudo-steady states for limited periods of time, when the changes occurring in the system (changes in concentrations of oxygen, fuel substrates, ADP) do not exert significant effects on metabolic fluxes (respiration, phosphorylation). Such pseudo-steady states require saturating levels of substrates to be maintained and thus depend on the kinetics of the processes under investigation.

Protonmotive force, Δp_{mt} : The protonmotive force, Δp_{mt} ,

$$\Delta p_{\text{mt}} = \Delta \Psi_{\text{mt}} + \Delta \mu_{\text{H}^+} / F \quad (1)$$

is composed of an electric part, $\Delta \Psi_{\text{mt}}$, which is the potential difference (difference of charge) across the inner mt-membrane, and a chemical part, $\Delta \mu_{\text{H}^+} / F$, which stems from the difference of pH across the mt-membrane. Protonmotive means that protons are moved across the mt-membrane at ΔpH maintained across the mt-membrane,

Kommentiert [PG6]: This section is far more complex to follow but I do not see the way to facilitate the understanding of all calculations and differences between flow, flux, ...

$$\Delta\mu_{\text{H}^+} = -\ln(10) \cdot RT \cdot \Delta\text{pH} \quad (2)$$

where RT is the gas constant times absolute temperature. $\ln(10) \cdot RT = 5.708$ and 5.938 $\text{kJ} \cdot \text{mol}^{-1}$ at 25 and 37 $^{\circ}\text{C}$, respectively. The Faraday constant, $F = N_{\text{A}}$, is the product of the elementary charge, e [C] and the Avogadro (or Loschmidt) constant. F yields the conversion between electric force expressed in joules per coulomb or Volt [$\text{V}=\text{J}/\text{C}$] and chemical force, $\Delta\mu_{\text{H}^+}$, with the unit joules per mole [J/mol]. $\ln(10) \cdot RT/F = 59.16$ and 61.54 mV at 25 and 37 $^{\circ}\text{C}$, respectively. For a ΔpH of 1 unit, the chemical potential difference (Eq. 2) changes by 6 $\text{kJ} \cdot \text{mol}^{-1}$ and Δp_{mt} (Eq. 1) changes by 0.06 V. Since F equals 96.5 ($\text{kJ} \cdot \text{mol}^{-1})/\text{V}$, a membrane potential of -0.2 V (Eq. 1) equals a chemiosmotic potential difference, $\Delta\tilde{\mu}_{\text{H}^+}$, of 19 $\text{kJ} \cdot \text{mol}^{-1}$. H^+_{out} . Considering a driving force of -470 $\text{kJ} \cdot \text{mol}^{-1}$ O_2 for oxidation, the thermodynamic limit of the H^+/O_2 ratio is reached at a value of $470/19 = 24$, compared to a mechanistic stoichiometry of 20 ($\text{H}^+/\text{O}=10$).

The protonmotive force is *maximum* in the LEAK state of well coupled mitochondria, driven by LEAK respiration at a minimum backflux of protons to the matrix side. Δp_{mt} is *high* in the OXPHOS state when it drives phosphorylation, and *very low* in the ETS state when uncouplers shortcircuit the proton cycle.

Forces and flows in physics and irreversible thermodynamics: According to the definition in physics, a potential difference and as such the “protonmotive force”, Δp_{mt} , is not a force (Cohen et al 2008). The fundamental forces of physics are distinguished from the generalized *motive* forces (e.g. Δp_{mt}) of statistical and irreversible thermodynamics. Complementary to the attempt towards unification of fundamental forces defined in physics, the style of thinking of Nobel laureates Lars Onsager, Erwin Schrödinger, Ilya Prigogine and Peter Mitchell (even if expressed in apparently inconsistent terms) is related to the diversity of conjugated flow-force relationships, the product of which links to the dissipation function and the Second Law of thermodynamics (Prigogine 1967; Schrödinger 1944). A generalized ‘motive’ force is the change of potentially available or ‘free’ energy (exergy) per ‘motive’

unit (force=exergy/motive unit; **in integral form, this definition takes care of isothermal and non-isothermal processes**). A potential difference is, in the framework of flow-force relationships, a generalized force, F_{tr} , involved in an exergy transformation, defined as the partial derivative of Gibbs energy per advancement, $\partial_{tr}\zeta$, of the transformation, tr (the motive unit in the transformation): $F_{tr} = \partial_{tr}G/\partial_{tr}\zeta$ (Gnaiger 1993a,b). This formal generalization represents an appreciation of the conceptual beauty of Peter Mitchel's innovation of the protonmotive force against the background of the established paradigm of the electromotive force (emf) defined at the limit of zero current (Cohen et al 2008). In chemical reactions and osmotic or diffusion processes occurring in a closed heterogenous system, such as a chamber containing isolated mitochondria, scalar transformations occur without measured spatial direction but between separate compartments (translocation between the matrix and extramitochondrial space) or between energetically separated chemical substances (reactions from substrates to products). Hence the corresponding fluxes are not vectorial but scalar, and are expressed per volume and not per membrane area. The corresponding generalized forces are also scalar, expressed in units $[J\cdot mol^{-1}]$. In a scalar electric transformation (flux of charge or current from the matrix space to the intermembrane and extramitochondrial space) the effective force is the mt-membrane potential, $\Delta\Psi_{mt}$ $[V=J\cdot C^{-1}]$. For comparison, in a mechanical, vectorial advancement, $\partial_{me}\zeta$ [m], the unit of the force is newton, F_{me} $[N=J\cdot m^{-1}]$, and the 'flow' is the velocity, $v = \partial_{me}\zeta/\partial t$ $[m\cdot s^{-1}]$, such that the flow·force product yields mechanical power, P_{me} [W] (Cohen et al 2008). The corresponding vectorial 'flux' (flow density per area) is velocity per cross-sectional area $[s^{-1}\cdot m^{-1}]$. The scalar 'flux' lacks spatial information in a given volume, such that flux (**flow density per volume-density** $[s^{-1}\cdot m^{-2}]$) **times force yields power density (per volume), P_{Vme} $[W\cdot m^{-3}]$.**

Coupling, efficiency and power: In energetics (ergodynamics) coupling is defined as an exergy transformation fuelled by the advancement of an exergonic (downhill) input process driving the advancement of an endergonic (uphill) output process. The (negative)

Kommentiert [PG7]: It is not clear along the text when "∂" and "d" is used.

Kommentiert [PG8]: This part could need further clarification.

output/input power ratio is the efficiency of a coupled energy transformation. Power, $P_{tr} = \partial_{tr}G/dt$ [$W=J\cdot s^{-1}$], is closely linked to the dissipation function (Prigogine 1967) and is the product of flow, $I_{tr}=d_{tr}\xi/dt$ [$x_{tr}\cdot s^{-1}$] times generalized force, $F_{tr} = \partial_{tr}G/\partial_{tr}\xi$ [$J\cdot x_{tr}^{-1}$] (Gnaiger 1993b).

3.2. Normalization: flows and fluxes

Application of common and generally defined units is required for direct transfer of reported results into a database. The second [s] is the *SI* unit for the base quantity time. The term 'rate' is too general and not useful for a database (Fig. 6).

Fig. 6. Different meanings of rate may lead to confusion, if the normalization is not sufficiently specified. Results are frequently expressed as mass-specific flux, J_m , per mg protein, dry or wet

weight, ignoring the fundamental difference between weight and mass. Cell volume or mitochondrial volume may be used for normalization (volume-specific flux, J_{Vce} or J_{Vmt}), which then must be clearly distinguished from flux, J_V , expressed for methodological reasons per volume of the measurement chamber.

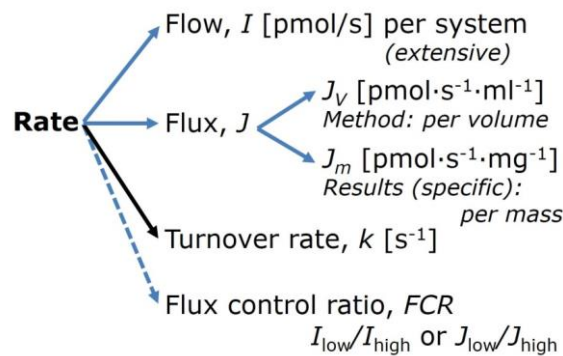

Flow, I , per instrumental system: In analogy to electric terms, flow as an extensive quantity (I ; per system) is distinguished from flux as a size-specific quantity (J ; per system size) (Fig. 6). Electric current is a flow, I_{el} [$A = C\cdot s^{-1}$], per system (extensive quantity).

Extensive quantities: An extensive quantity increases proportional with system size. The magnitude of an extensive quantity is completely additive for non-interacting subsystems,

such as mass or flow expressed per defined system. The magnitude of these quantities depends on the extent or size of the system (Cohen et al 2008).

Size-specific quantities: ‘The adjective *specific* before the name of an extensive quantity is often used to mean *divided by mass*’ (Cohen et al 2008). A mass-specific quantity (e.g. mass-specific flux is flow divided by mass of the system) is independent of the extent of non-interacting homogenous subsystems. If mass-specific oxygen flux is constant and independent of system size (expressed as mass), then there is no interaction between the subsystems. The well-established scaling law in respiratory physiology reveals a strong interaction of oxygen consumption and body mass by the fact that mass-specific basal metabolic rate (oxygen flux) does not increase proportionally and linearly with body mass, whereas maximum mass-specific oxygen flux, $V_{O_{2max}}$, is constant across a large range of body mass (Weibel and Hoppeler 2005).

Flux per volume of the experimental system, J_V : When dividing an extensive quantity by system size (the cross-sectional area of a wire or area of a membrane), a size-specific quantity is obtained, which is electric flux (electric current density), J_{el} [$A \cdot m^{-2} = C \cdot s^{-1} \cdot m^{-2}$]. In open systems, external flows (such as oxygen supply) are distinguished from internal transformations (metabolic flow, oxygen consumption). In closed systems, external flows of all substances are zero and oxygen consumption (internal flow), I_{O_2} [$pmol \cdot s^{-1}$], causes a decline of the amount of oxygen in the system, n_{O_2} [nmol]. Normalization of these quantities for the volume of the system, V [$ml = cm^3$] yields volume-specific oxygen flux, $J_{V,O_2} = I_{O_2}/V$ [$pmol \cdot s^{-1} \cdot ml^{-1}$] and oxygen concentration, $[O_2]$ or $c_{O_2} = n_{O_2}/V$ [$nmol \cdot ml^{-1} = \mu mol \cdot l^{-1} = \mu M$]. Volume-specific metabolic oxygen flux, J_{V,O_2} , depends on the specific activity and the concentration of the mt-preparation in the measurement system, mt_{prep}/V .

Size-specific flux, J : J_{V,O_2} should be compared with instrumental resolution and is thus relevant mainly for methodological reasons. Normalization for mt_{prep}/V is required for

reporting respiratory results, e.g. in terms of respiration per mass, W_{mtprep} (of tissue homogenate or permeabilized fibres), $J_{\text{O}_2} = J_{V,\text{O}_2}/(W_{\text{mtprep}}/V) = I_{\text{O}_2}/W_{\text{mtprep}}$.

Flow, I , per experimental model: A special case of normalization is encountered in respiratory studies with permeabilized (or intact) cells. If respiration is expressed per million cells, the oxygen flow per measurement system is replaced by the oxygen flow, I_{O_2} , per cell (or per 10^6 cells). Similarly, oxygen flow can be calculated from volume-specific oxygen flux, J_{V,O_2} [$\text{pmol}\cdot\text{s}^{-1}\cdot\text{ml}^{-1}$] (per V of the measurement chamber), divided by the number density of cells, $C=N_{\text{ce}}/V$ [$10^6\cdot\text{ml}^{-1}$], where N_{ce} is the number of cells in the chamber. Cellular oxygen flow can be compared only between cells of identical cell size, after normalization to a size-specific oxygen flux or after normalization by a mt-marker (Renner et al, 2003).

3.3. Conversion: oxygen, protons, ATP

J_{O_2} is coupled in mitochondrial steady states to proton cycling, $J_{\text{eH}^+} = J_{\text{H}^+\text{out}} = J_{\text{H}^+\text{in}}$ (Fig. 1). $J_{\text{H}^+\text{out}}$ [$\text{pmol}\cdot\text{s}^{-1}\cdot\text{ml}^{-1}$] is converted into an electric flux (per volume), J_{el} [$\mu\text{C}\cdot\text{s}^{-1}\cdot\text{ml}^{-1}=\mu\text{A}\cdot\text{ml}^{-1}$] = $J_{\text{H}^+\text{out}}$ [$\text{pmol}\cdot\text{s}^{-1}\cdot\text{ml}^{-1}$] $\cdot F$ [$\text{C}\cdot\text{mol}^{-1}$] $\cdot 10^{-6}$. F is the Faraday constant (96,485.3 $\text{C}\cdot\text{mol}^{-1}$). At a $J_{\text{H}^+\text{out}}/J_{\text{O}_2}$ ratio or $\text{H}^+\text{out}/\text{O}_2$ of 20 ($\text{H}^+\text{out}/\text{O}=10$), a volume-specific oxygen flux of 100 $\text{pmol}\cdot\text{s}^{-1}\cdot\text{ml}^{-1}$ would correspond to a proton flux of 2,000 $\text{pmol}\cdot\text{s}^{-1}\cdot\text{ml}^{-1}$ or volume-specific current of 193 $\mu\text{A}\cdot\text{ml}^{-1}$.

$$J_{\text{el}} [\mu\text{A}\cdot\text{ml}^{-1}] = J_{\text{H}^+\text{out}} \cdot F \cdot 10^{-6} [\text{pmol}\cdot\text{s}^{-1}\cdot\text{ml}^{-1} \cdot \mu\text{C}\cdot\text{pmol}^{-1}] \quad (3.1)$$

$$J_{\text{el}} [\mu\text{A}\cdot\text{ml}^{-1}] = J_{V,\text{O}_2} \cdot (\text{H}^+\text{out}/\text{O}_2) \cdot F \cdot 10^{-6} [\mu\text{A}\cdot\text{ml}^{-1}=\mu\text{C}\cdot\text{s}^{-1}\cdot\text{ml}^{-1}] \quad (3.2)$$

ETS capacity in various human cell types including HEK 293, primary HUVEC and fibroblasts ranges from 50 to 180 $\text{pmol}\cdot\text{s}^{-1}\cdot 10^{-6}$ cells (see Gnaiger 2014). At 100 $\text{pmol}\cdot\text{s}^{-1}\cdot 10^{-6}$ cells corrected for ROX, the current across the mt-membranes, I_{el} , approximates 193 $\mu\text{A}\cdot 10^{-6}$ cells or 0.2 nA per cell. For an extension of quantitative bioenergetics from the molecular to the human scale (transmembrane proton flux equivalent to 520 A in an adult) see Rich (2003).

In the OXPHOS state or at high [ADP], $J_{H^{+}in}$ drives a phosphorylation flux, $J_{V, \gg P}$, of 500 $\text{pmol} \cdot \text{s}^{-1} \cdot \text{ml}^{-1}$ at a $H^{+}_{in}/\gg P$ ratio of 3.7 (nH^{+} ; Fig. 2B).

For NADH- and succinate-linked respiration, the mechanistic $\gg P/O_2$ ratio is calculated at 20/3.7 and 12/3.7 (Eq 2), or 5.4 and 3.3 (equivalent to $\gg P/O$ of 2.7 and 1.6; Watt et al 2010), in direct agreement with the measured $\gg P/O$ ratio for succinate of 1.58 ± 0.02 (Gnaiger et al 2000),

$$\gg P/O_2 = (H^{+}_{out}/O_2)/(H^{+}_{in}/\gg P) \quad (4)$$

In summary,

$$J_{V, \gg P} [\text{pmol} \cdot \text{s}^{-1} \cdot \text{ml}^{-1}] = J_{V, O_2} (H^{+}_{out}/O_2)/(H^{+}_{in}/\gg P) \quad (5.1)$$

$$J_{V, \gg P} [\text{pmol} \cdot \text{s}^{-1} \cdot \text{ml}^{-1}] = J_{V, O_2} (\gg P/O_2) \quad (5.2)$$

Relating the experimental results on isolated mitochondria and the proton pumps as molecular machines to energy metabolism of the intact cell, the cellular $\gg P/O_2$ based on oxidation of glycogen is increased by the glycolytic substrate-level phosphorylation of 3 $\gg P/\text{Glyc}$, equivalent to 0.5 $\gg P/O_2$. Added to the mitochondrial $\gg P/O_2$ ratio of 5.4, this yields a bioenergetic cell physiological $\gg P/O_2$ ratio close to 6. Two NADH equivalents are formed during glycolysis and transported from the cytosol into the mitochondrial matrix, the energetic cost of which must potentially be taken into account. Taken together with substrate-level phosphorylation in the TCA cycle, this high $\gg P/O_2$ ratio is not a feature of proton translocation and OXPHOS studied in isolation, but integrates mitochondrial physiology with energy transformation in the living cell (Gnaiger 1993b).

4. Conclusions

With a perspective to extend the present recommendations on coupling control (part 1) to pathway control of mitochondrial respiration (part 2), substrate-uncoupler-inhibitor-titration (SUIT) protocols and harmonization of experimental procedures, MITOEAGLE will be a gateway and milestone to better diagnose mitochondrial respiratory defects which are

linked to genetic variations, age-related health risks, gender-specific mitochondrial performance, life style with its consequences on degenerative diseases, and environmental exposure to toxicological agents.

References (incomplete)

- Altmann R (1894) Die Elementarorganismen und ihre Beziehungen zu den Zellen. Zweite vermehrte Auflage. Verlag Von Veit & Comp, Leipzig:160 pp.
- Chance B, Williams GR. Respiratory enzymes in oxidative phosphorylation. IV. The respiratory chain. *J Biol Chem* 1955;217:429-38.
- Chance B, Williams GR. The respiratory chain and oxidative phosphorylation. *Adv Enzymol* 1956;17:65-134.
- Cohen ER, Cvitas T, Frey JG, Holmström B, Kuchitsu K, Marquardt R, Mills I, Pavese F, Quack M, Stohner J, Strauss HL, Takami M, Thor HL. Quantities, Units and Symbols in Physical Chemistry, IUPAC Green Book 2008;3rd Edition, 2nd Printing, IUPAC & RSC Publishing, Cambridge.
- Garlid KD, Semrad C, Zinchenko V (1993) Does redox slip contribute significantly to mitochondrial respiration? In: Schuster S, Rigoulet M, Ouhabi R, Mazat J-P (eds) Modern trends in biothermokinetics. Plenum Press, New York, London:287-93.
- Gnaiger E. Efficiency and power strategies under hypoxia. Is low efficiency at high glycolytic ATP production a paradox? In: Surviving Hypoxia: Mechanisms of Control and Adaptation. Hochachka PW, Lutz PL, Sick T, Rosenthal M, Van den Thillart G (eds) CRC Press, Boca Raton, Ann Arbor, London, Tokyo 1993:77-109.
- Gnaiger E. Nonequilibrium thermodynamics of energy transformations. *Pure Appl Chem* 1993;65:1983-2002.
- Gnaiger E. Bioenergetics at low oxygen: dependence of respiration and phosphorylation on oxygen and adenosine diphosphate supply. *Respir Physiol* 2001;128:277-97.

- Gnaiger E. Mitochondrial pathways and respiratory control. An introduction to OXPHOS analysis. 4th ed. Mitochondr Physiol Network 2014;19.12. Oroboros MiPNet Publications, Innsbruck:80 pp.
- Gnaiger E (2009) Capacity of oxidative phosphorylation in human skeletal muscle. New perspectives of mitochondrial physiology. *Int J Biochem Cell Biol* 41:1837-45.
- Gnaiger E, Méndez G, Hand SC. High phosphorylation efficiency and depression of uncoupled respiration in mitochondria under hypoxia. *Proc Natl Acad Sci USA* 2000b;97:11080-5.
- Komlódi T, Tretter L. Methylene blue stimulates substrate-level phosphorylation catalysed by succinyl-CoA ligase in the citric acid cycle. *Neuropharmacology* 2017;123:287-98.
- Lemasters JJ. The ATP-to-oxygen stoichiometries of oxidative phosphorylation by rat liver mitochondria. *J Biol Chem* 1984;259:13123-30.
- Lemieux H, Blier PU, Gnaiger E. Remodeling pathway control of mitochondrial respiratory capacity by temperature in mouse heart: electron flow through the Q-junction in permeabilized fibers. *Sci Rep* 2017;7:2840.
- Miller GA (1991) *The science of words*. Scientific American Library New York:276 pp
- Mitchell P, Moyle J. Respiration-driven proton translocation in rat liver mitochondria. *Biochem J* 1967;105:1147-62.
- Prigogine I. *Introduction to thermodynamics of irreversible processes*. Interscience, New York, 1967;3rd ed.
- Puchowicz MA, Varnes ME, Cohen BH, Friedman NR, Kerr DS, Hoppel CL. Oxidative phosphorylation analysis: assessing the integrated functional activity of human skeletal muscle mitochondria – case studies. *Mitochondrion* 2004;4:377-85.
- Rich P (2003) Chemiosmotic coupling: The cost of living. *Nature* 421:583.

- Rostovtseva TK, Sheldon KL, Hassanzadeh E, Monge C, Saks V, Bezrukov SM, Sackett DL. Tubulin binding blocks mitochondrial voltage-dependent anion channel and regulates respiration. *Proc Natl Acad Sci USA* 2008;105:18746-51.
- Rustin P, Parfait B, Chretien D, Bourgeron T, Djouadi F, Bastin J, Rötig A, Munnich A. Fluxes of nicotinamide adenine dinucleotides through mitochondrial membranes in human cultured cells. *J Biol Chem* 1996;271:14785-90.
- Schrödinger E. *What is life? The physical aspect of the living cell.* Cambridge Univ Press, 1944.
- Watt IN, Montgomery MG, Runswick MJ, Leslie AG, Walker JE. Bioenergetic cost of making an adenosine triphosphate molecule in animal mitochondria. *Proc Natl Acad Sci U S A* 2010;107:16823-7.
- Weibel ER, Hoppeler H. Exercise-induced maximal metabolic rates scales with muscle aerobic capacity. *J Exp Biol* 2005;208:1635-44.

Work flow

2017-08-10: Integration of suggestions and corrections by Timea Komlodi and Andras Meszaros.

2017-08-08 to 09: Updated versions by Erich Gnaiger.

2017-08-02: Updated ms summarizing WG1 input by Javier Iglesias-Gonzalez.

2017-08-29: Version 3 on website by Erich Gnaiger

http://www.mitoeagle.org/index.php/Mitochondrial_respiratory_control:_MITOEAGLE_recommendations_1

2017-07-28 to 29: Obergurgl MITOEAGLE Workshop: WG1 – group discussion and edits on draft 2.

2017 Mar 21-23: Barcelona MITOEAGLE Workshop: WG1 – group discussion and